

## DISTRIBUTION OF THE RATIO OF DISTANCES TO THE FIRST AND SECOND NEAREST FACILITIES

Masashi Miyagawa  
*University of Yamanashi*

(Received August 18, 2016; Revised January 28, 2017)

*Abstract* This paper deals with the ratio of the distances to the first and second nearest facilities. The ratio represents the reliability of facility location when the nearest facility is closed and customers are serviced by the second nearest facility. The distribution of the ratio is derived for grid and random patterns of facilities. Distance is measured as the Euclidean and rectilinear distances. The distribution shows how the ratio is distributed in a study region, and will supply building blocks for facility location models with closing of facilities. The distribution of the ratio of the road network distances is also calculated for actual facility location.

**Keywords:** Facility planning, reliability, Euclidean distance, rectilinear distance

### 1. Introduction

Facility location problems have been addressed in various fields such as geography, economics, and operations research. The most frequently used assumption in location models is that customers get service from their nearest facility. Facilities might, however, be closed or disrupted due to accidents and disasters. If the nearest facility is closed, customers have to use more distant facilities. Not only the distance to the nearest facility but also the distance to the second nearest facility is thus important particularly when locating emergency facilities.

The service from the second nearest facility has been considered in location analysis. Weaver and Church [20] proposed the vector assignment  $p$ -median problem, where a certain percentage of customers could be serviced by the  $k$ th nearest facility. The problem was extended by Lei and Tong [10] to the expected median location problem and Lei and Church [9] to the vector assignment ordered median problem. Pirkul [17] studied a similar problem in which customers are served by two facilities designated as primary and secondary facilities. Drezner [4] developed the unreliable  $p$ -median problem, where customers are assigned to the  $k$ th nearest facility when closer facilities fail. Berman et al. [1] extended the problem by relaxing the assumption that the probability of facility failure is the same for all facilities. Snyder and Daskin [18] formulated the reliability  $p$ -median problem and the reliability fixed-charge location problem. They made an ordered assignment of customers to facilities. Lei and Church [8] presented generalized closest assignment constraints in terms of multiple levels of closeness. Miyagawa [13] found the optimal location that minimizes the average distance to the nearest open facility when some of the existing facilities are closed.

If the distance to the second nearest facility is as short as that to the first nearest facility, the facility location can be considered to be reliable. The ratio of the two distances then represents the reliability of facility location. Although the ratio alone is insufficient for evaluating the reliability, the ratio has at least three advantages. First, the single objective

approach based on the ratio of the distances is more analytically tractable than the multi objective approach that simultaneously considers the first and second nearest distances. Second, the spatial distribution of the service level can be expressed by the contour of the ratio, which leads to an intuitive understanding. Finally, as will be shown in Section 4, the ratio is more convenient than the difference between the distances, which is also a criterion of reliability, as discussed by Miyagawa [15].

In this paper, we derive the distribution of the ratio of the distances to the first and second nearest facilities. The distribution of the ratio shows how the ratio is distributed in a study region, and will supply building blocks for facility location models with closing of facilities. To obtain analytical expressions for the distribution, facilities are represented as points of grid and random patterns, and distance is measured as the Euclidean and rectilinear distances. The analytical expressions allow us to examine fundamental characteristics of the ratio of the distances. Since actual patterns of facilities can be regarded as intermediate between grid and random patterns, the theoretical results of these extremes serve as a basis for empirical analysis of actual patterns.

The distributions of the first and second nearest Euclidean distances have been derived for grid and random patterns [3, 6, 13, 19]. The distributions of the first and second nearest rectilinear distances have also been derived [7, 12]. For the relationship between the first and second nearest distances, the joint distribution of the distances [14], the distribution of the sum of the distances [16], and the distribution of the difference between the distances [15] have been obtained. The distribution of the ratio of the distances, which we address in this paper, provides another understanding of the first and second nearest distances.

The rest of this paper is organized as follows. The next section derives the distribution of the ratio of the Euclidean distances to the first and second nearest facilities. Section 3 derives the distribution of the ratio of the rectilinear distances. Section 4 compares the ratio of the distances with the difference between the distances. Section 5 examines the distribution of the ratio of the road network distances. The final section presents concluding remarks.

## 2. Euclidean Distance

Let  $R_1$  and  $R_2$  be the Euclidean distances from a randomly selected location in a study region to the first and second nearest facilities, respectively. Let  $W = R_2/R_1$  be the ratio of the distances. The contour of the ratio  $W$  is given by a circle, as depicted in Figure 1a. Recall that the locus of points that have a given ratio of distances to two fixed points forms a circle (circle of Apollonius). In this section, we derive the distribution of the ratio of the Euclidean distances for the grid and random patterns of facilities.

### 2.1. Grid pattern

Suppose that facilities are regularly distributed on a square grid with spacing  $a$ . Let  $F(w)$  be the cumulative distribution function of  $W$ , that is, the probability that  $W \leq w$ .  $F(w)$  is given by

$$F(w) = \frac{S(w)}{S}, \quad (2.1)$$

where  $S$  and  $S(w)$  are the area of the study region and the area of the region such that  $W \leq w$  in the study region, respectively. The study region can be confined to the region where two facilities are the first and second nearest, which is the square centered at the midpoint of the facilities with side length  $a/\sqrt{2}$ , as shown in Figure 1b. The area of the study region is then  $S = a^2/2$ . Set the coordinate system as shown in Figure 1b, where

facilities are at  $(-a/2, 0), (a/2, 0)$ . The ratio of the distances from a location  $(x, y)$  ( $x \geq 0$ ) to the facilities is

$$W = \sqrt{\left(x + \frac{a}{2}\right)^2 + y^2} / \sqrt{\left(x - \frac{a}{2}\right)^2 + y^2}. \tag{2.2}$$

The locus such that  $W = w$  is the circle expressed as

$$\left\{x - \frac{a(w^2 + 1)}{2(w^2 - 1)}\right\}^2 + y^2 = \frac{a^2 w^2}{(w^2 - 1)^2}. \tag{2.3}$$

The region such that  $W \leq w$  is given by the light gray region in Figure 1b. Then,

$$S(w) = \frac{a^2 \left(w^4 - 2w^2 - 1 + 2\sqrt{2w^2 - 1} - 4w^2 \arcsin \frac{\sqrt{2w^2 - 1} - 1}{2w}\right)}{2(w^2 - 1)^2}. \tag{2.4}$$

Substituting  $S$  and  $S(w)$  into Equation (2.1) yields

$$F(w) = \frac{w^4 - 2w^2 - 1 + 2\sqrt{2w^2 - 1} - 4w^2 \arcsin \frac{\sqrt{2w^2 - 1} - 1}{2w}}{(w^2 - 1)^2}. \tag{2.5}$$

Differentiating  $F(w)$  with respect to  $w$  yields the probability density function of  $W$  as

$$f(w) = \frac{-2w \left\{6(w^2 - 1) + (\sqrt{2w^2 - 1} + 1) \left(2 + \sqrt{2w^2 + 2\sqrt{2w^2 - 1}}\right)\right\}}{(w^2 - 1)^2 \left\{w^2 (\sqrt{2w^2 - 1} + 2) - 1\right\}} + \frac{8w(w^2 + 1)}{(w^2 - 1)^3} \arcsin \frac{\sqrt{2w^2 - 1} - 1}{2w}. \tag{2.6}$$

Note that  $f(w)$  is independent of the facility spacing  $a$ . The distribution of the ratio  $f(w)$  is shown in Figure 2a.  $f(w)$  has its maximum at  $w = 1$  ( $R_1 = R_2$ ) and decreases with  $w$ .

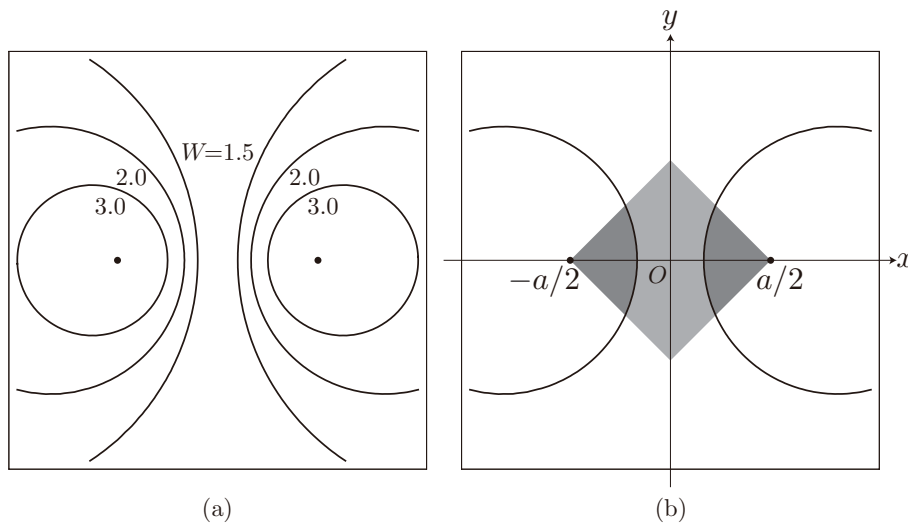

Figure 1: (a) Contour of the ratio of the Euclidean distances; (b) Region such that  $W \leq w$

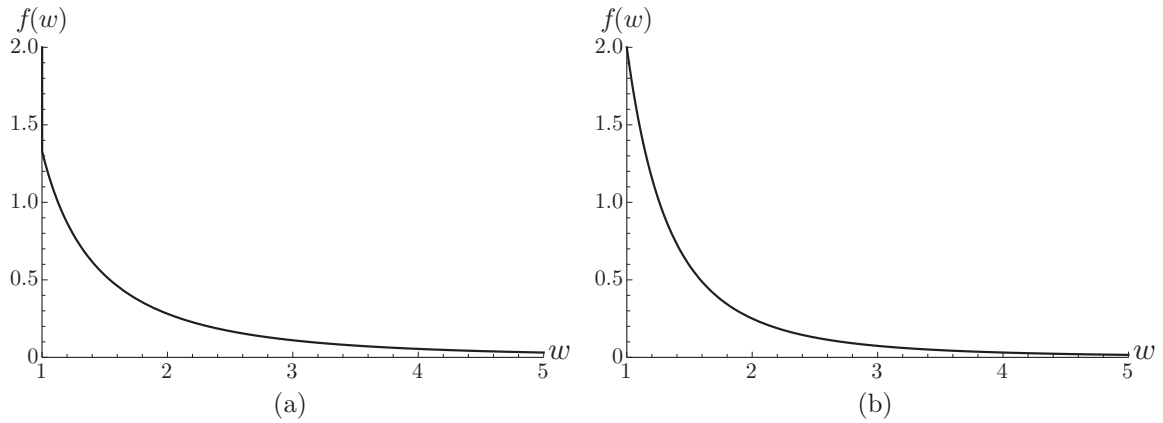

Figure 2: Distribution of the ratio of the Euclidean distances: (a) Grid; (b) Random

**2.2. Random pattern**

Suppose that facilities are randomly distributed with density  $\rho$ . The cumulative distribution function  $F(w)$  can be obtained from the joint distribution of  $R_1$  and  $R_2$ . The joint probability density function of  $R_1$  and  $R_2$ , denoted by  $f(r_1, r_2)$ , for the random pattern was derived by Miyagawa [14] as

$$f(r_1, r_2) = 4\rho^2\pi^2r_1r_2 \exp(-\rho\pi r_2^2). \tag{2.7}$$

Integrating  $f(r_1, r_2)$  in the region such that  $W \leq w$  on the  $r_1$ - $r_2$  plane, as shown in Figure 3, yields

$$\begin{aligned} F(w) &= \iint_{r_2 \leq wr_1} f(r_1, r_2) \, dr_1 dr_2 \\ &= \int_0^\infty \int_{r_1}^{wr_1} f(r_1, r_2) \, dr_2 dr_1 \end{aligned} \tag{2.8}$$

$$= 1 - \frac{1}{w^2}. \tag{2.9}$$

Differentiating  $F(w)$  with respect to  $w$  yields

$$f(w) = \frac{2}{w^3}. \tag{2.10}$$

The distribution of the ratio  $f(w)$  is shown in Figure 2b. Note that  $f(w)$  for small  $w$  for the random pattern is greater than that for the grid pattern. This is because if  $R_1$  is small,  $R_2$  (and  $W$ ) is always large for the grid pattern but can be small for the random pattern. It should be noted that the distribution for the grid pattern is difficult to obtain from the joint distribution. This is the reason why we use a geometric approach to derive the distribution for the grid pattern.

**3. Rectilinear Distance**

Although the Euclidean distance is a good approximation for the actual travel distance, the rectilinear distance is more suitable for cities with a grid road network [2, 5, 11]. The rectilinear distance between two points  $(x_1, y_1)$  and  $(x_2, y_2)$  is defined as  $|x_1 - x_2| + |y_1 - y_2|$ . Let  $R_1$  and  $R_2$  be the rectilinear distances from a randomly selected location in a study

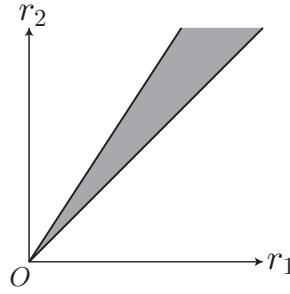

Figure 3: Region such that  $W \leq w$  on the  $r_1$ - $r_2$  plane

region to the first and second nearest facilities, respectively. The contour of the ratio  $W = R_2/R_1$  is depicted in Figure 4a. In this section, we derive the distribution of the ratio of the rectilinear distances for the grid and random patterns of facilities.

**3.1. Grid pattern**

The ratio of the distances from a location  $(x, y)$  ( $x \geq 0$ ) to the facilities  $(-a/2, 0), (a/2, 0)$  is

$$W = \left( \left| x + \frac{a}{2} \right| + |y| \right) / \left( \left| x - \frac{a}{2} \right| + |y| \right). \tag{3.1}$$

The locus such that  $W = w$  is

$$y = \begin{cases} \frac{w+1}{w-1}x - \frac{a}{2}, & x \leq \frac{a}{2}, y \geq 0, \\ -x + \frac{a(w+1)}{2(w-1)}, & x > \frac{a}{2}, y \geq 0, \\ -\frac{w+1}{w-1}x + \frac{a}{2}, & x \leq \frac{a}{2}, y < 0, \\ x - \frac{a(w+1)}{2(w-1)}, & x > \frac{a}{2}, y < 0. \end{cases} \tag{3.2}$$

The region such that  $W \leq w$  is given by the light gray region in Figure 4b. Then,

$$S(w) = \frac{a^2}{2} \left( 1 - \frac{2}{w} + \frac{2}{w+1} \right). \tag{3.3}$$

Substituting  $S$  and  $S(w)$  into Equation (2.1) yields

$$F(w) = 1 - \frac{2}{w} + \frac{2}{w+1}. \tag{3.4}$$

Differentiating  $F(w)$  with respect to  $w$  yields the probability density function of  $W$  as

$$f(w) = \frac{2}{w^2} - \frac{2}{(w+1)^2}. \tag{3.5}$$

The distribution of the ratio  $f(w)$  is shown in Figure 5.

**3.2. Random pattern**

The distribution of the ratio  $f(w)$  is similarly obtained from the joint distribution of  $R_1$  and  $R_2$ . The joint probability density function  $f(r_1, r_2)$  was derived by Miyagawa [14] as

$$f(r_1, r_2) = 16\rho^2 r_1 r_2 \exp(-2\rho r_2^2). \tag{3.6}$$

Substituting  $f(r_1, r_2)$  into Equation (2.8) and differentiating  $F(w)$  with respect to  $w$  yield

$$f(w) = \frac{2}{w^3}, \tag{3.7}$$

which is the same as  $f(w)$  of the Euclidean distances.

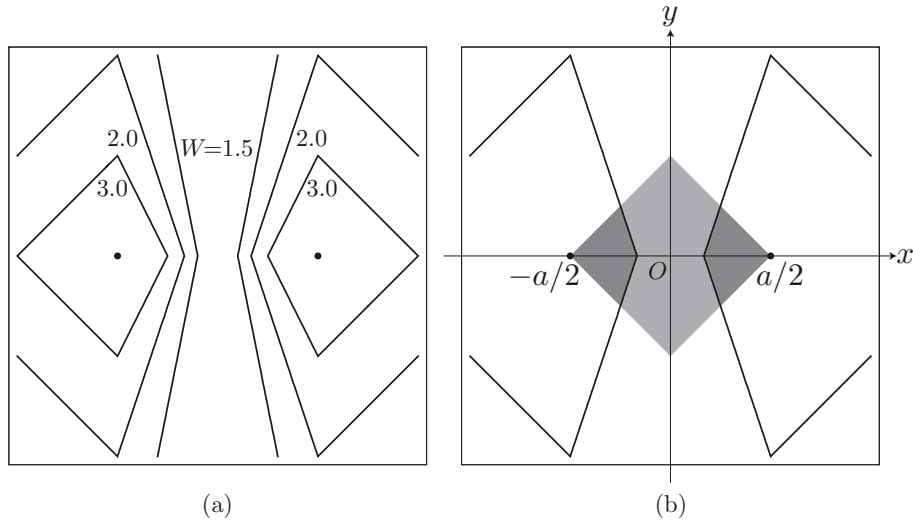

Figure 4: (a) Contour of the ratio of the rectilinear distances; (b) Region such that  $W \leq w$

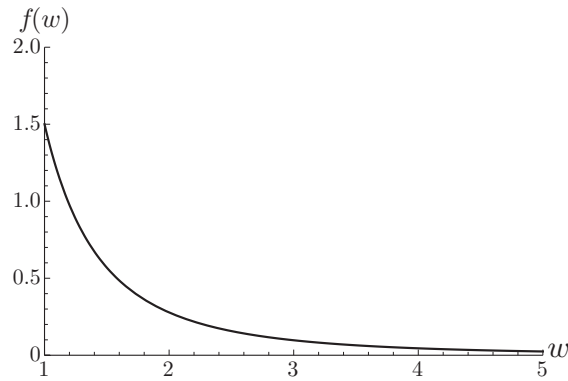

Figure 5: Distribution of the ratio of the rectilinear distances

#### 4. Comparison with Difference between Distances

Miyagawa [15] dealt with the difference between the distances to the first and second nearest facilities. The difference also represents the reliability of facility location because the difference is regarded as the additional travel distance of customers when the nearest facility is closed. In this section, we compare the ratio of the distances with the difference between the distances.

Let  $V = R_2 - R_1$  be the difference between the Euclidean distances to the first and second nearest facilities. The distributions of  $V$ , denoted by  $f(v)$ , for the grid and random patterns are shown in Figure 6.  $f(v)$  as well as  $f(w)$  suggests that the random pattern is more reliable than the grid pattern. In fact,  $f(v)$  for small  $v$  for the random pattern is greater than that for the grid pattern. The major difference between  $f(w)$  and  $f(v)$  is whether or not the distributions depend on the density of facilities. The ratio of the distances is independent of the density, whereas the difference between the distances decreases as the density increases. It follows that if the reliability is measured as the difference, the effect of the density should be taken into account. The ratio is therefore more convenient than the difference for evaluating the reliability of facility location.

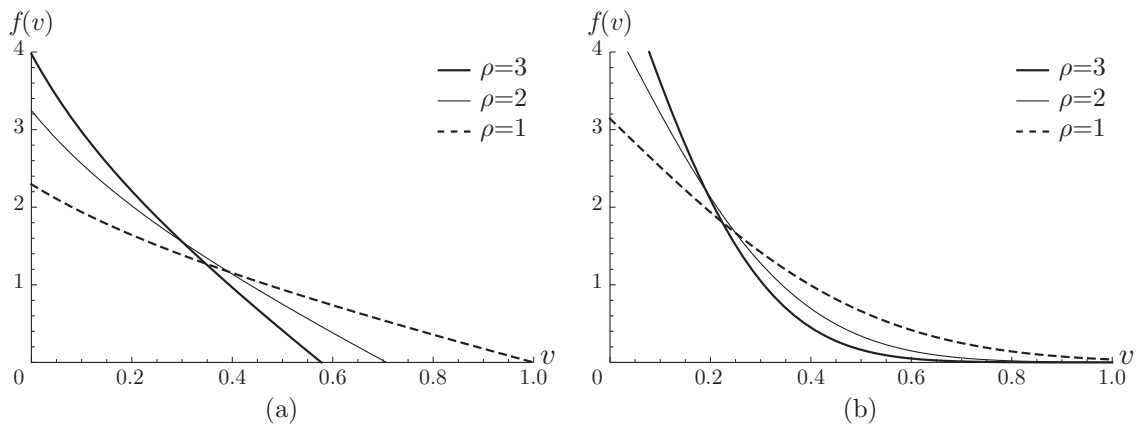

Figure 6: Distribution of the difference between the Euclidean distances: (a) Grid; (b) Random

### 5. Road Network Distance

In this section, we examine the distribution of the ratio of the road network distances for actual facility location to discuss whether the distributions for the grid and random patterns can be applied to actual patterns. As an example, we consider 32 hospitals and 60 police stations on the road network of Setagaya, Japan, as shown in Figure 7, where black circles represent facilities. The data were extracted from Digital Map 25000 (Spatial Data Framework) provided by Geospatial Information Authority of Japan.

Let  $R_1$  and  $R_2$  be the road network distances from a node (intersection) to the first and second nearest facilities, respectively. Dark gray circles in Figure 7 represent the nodes such that  $W = R_2/R_1 < 2$ . The boundary of the set of the nodes seems to form a circle. Recall that the contour of the ratio is given by a circle, as depicted in Figure 1a. The nodes with low reliability (high  $W$ ) are distributed near facilities. The normalized histograms of the ratio for all nodes are shown in Figure 8. The solid and dotted curves are the distributions of the ratio of the Euclidean and rectilinear distances for the grid and random patterns. Note that the distributions for the grid and random patterns can describe the distributions for the actual patterns.



Figure 7: Nodes such that  $W < 2$  in Setagaya, Japan: (a) Hospital; (b) Police station

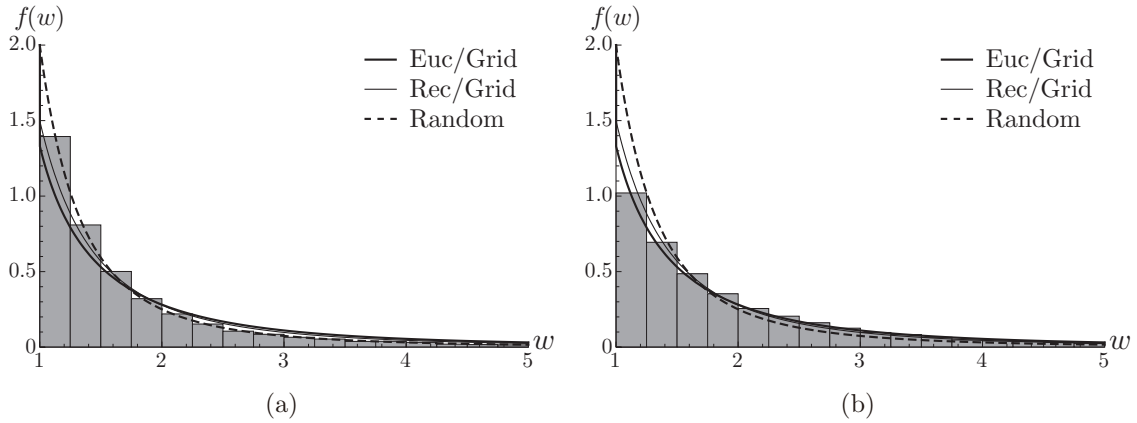

Figure 8: Distribution of the ratio of the road network distances: (a) Hospital; (b) Police station

For comparison with the difference between the distances, Figure 9 shows the nodes such that  $V = R_2 - R_1 < 0.4$  km. The nodes with low reliability (high  $V$ ) are also distributed near facilities. In contrast to the ratio case, the reliability of the nodes near the boundary of the region is tend to be low.



Figure 9: Nodes such that  $V < 0.4$  km in Setagaya, Japan: (a) Hospital; (b) Police station

### 6. Conclusions

This paper has derived the distribution of the ratio of the distances to the first and second nearest facilities. The analytical expressions for the distribution for grid and random patterns are useful for facility location models with closing of facilities as follows. First, they lead to an intuitive understanding of the spatial distribution of the service level. The contour of the ratio helps planners to find regions with low reliability. Second, they give an estimate for the service level of actual facility location. By comparing the distributions, we can evaluate the reliability of actual patterns. For example, if the ratio for an actual pattern is much greater than that for the grid and random patterns, relocating some facilities should be considered. Finally, they provide all the information about the ratio of the distances.



The average and standard deviation of the ratio, which can be used as objective functions, are obtained from the distribution.

An interesting topic for future work is to find the optimal location that minimizes the ratio of the distances. Addressing a facility location problem that simultaneously considers the efficiency and reliability would also be interesting.

### Acknowledgements

This research was supported by JSPS KAKENHI Grant Number 15K01185. I am grateful to anonymous reviewers for their helpful comments and suggestions.

### References

- [1] O. Berman, D. Krass, and M.B.C. Menezes: Facility reliability issues in network  $p$ -Median problems: Strategic centralization and co-location effects. *Operations Research*, **55** (2007), 332–350.
- [2] J. Brimberg, J.H. Walker, and R.F. Love: Estimation of travel distances with the weighted  $\ell_p$  norm: Some empirical results. *Journal of Transport Geography*, **15** (2007), 62–72.
- [3] M.F. Dacey: Two-dimensional random point patterns: A review and an interpretation. *Papers of the Regional Science Association*, **13** (1968), 41–55.
- [4] Z. Drezner: Heuristic solution methods for two location problems with unreliable facilities. *Journal of the Operational Research Society*, **38** (1987), 509–514.
- [5] D.A. Griffith, I. Vojnovic, and J. Messina: Distances in residential space: Implications from estimated metric functions for minimum path distances. *GIScience & Remote Sensing*, **49** (2012), 1–30.
- [6] T. Koshizuka: On the relation between the density of urban facilities and the distance to the nearest facility from a point in a given area. *Journal of the City Planning Institute of Japan*, **20** (1985), 85–90 (in Japanese).
- [7] R.C. Larson and A.R. Odoni: *Urban Operations Research* (Prentice Hall, Englewood Cliffs, NJ, 1981).
- [8] T.L. Lei and R.L. Church: Constructs for multilevel closest assignment in location modeling. *International Regional Science Review*, **34** (2011), 339–367.
- [9] T.L. Lei and R.L. Church: Vector assignment ordered median problem: A unified median problem. *International Regional Science Review*, **37** (2014), 194–224.
- [10] T.L. Lei and D. Tong: Hedging against service disruptions: an expected median location problem with site-dependent failure probabilities. *Journal of Geographical Systems*, **15** (2013), 491–512.
- [11] R.F. Love and J.G. Morris: Mathematical models of road travel distances. *Management Science*, **25** (1979), 130–139.
- [12] M. Miyagawa: Analysis of facility location using ordered rectilinear distance in regular point patterns. *FORMA*, **23** (2008), 89–95.
- [13] M. Miyagawa: Order distance in regular point patterns. *Geographical Analysis*, **41** (2009), 252–262.
- [14] M. Miyagawa: Joint distribution of distances to the first and the second nearest facilities. *Journal of Geographical Systems*, **14** (2012), 209–222.
- [15] M. Miyagawa: Distribution of the difference between distances to the first and the

- second nearest facilities. *Journal of the Operations Research Society of Japan*, **56** (2013), 167–176.
- [16] M. Miyagawa: Distribution of the sum of distances to the first and second nearest facilities. *Geographical Analysis*, **46** (2014), 321–333.
- [17] H. Pirkul: The uncapacitated facility location problem with primary and secondary facility requirements. *IIE Transactions*, **21** (1989), 337–348.
- [18] L.V. Snyder and M.S. Daskin: Reliability models for facility location: The expected failure cost case. *Transportation Science*, **39** (2005), 400–416.
- [19] H.R. Thompson: Distribution of distance to  $n$ th neighbour in a population of randomly distributed individuals. *Ecology*, **37** (1956), 391–394.
- [20] J.R. Weaver and R.L. Church: A median location model with nonclosest facility service. *Transportation Science*, **19** (1985), 58–74.

Masashi Miyagawa  
Department of Regional Social Management  
University of Yamanashi  
4-4-37 Takeda, Kofu  
Yamanashi 400-8510, Japan  
E-mail: [mmiyagawa@yamanashi.ac.jp](mailto:mmiyagawa@yamanashi.ac.jp)